



1.1.60

MODULO 105



Lismarca





PORTATA TENDE - CURTAIN WEIGHT - PESO CORTINAS

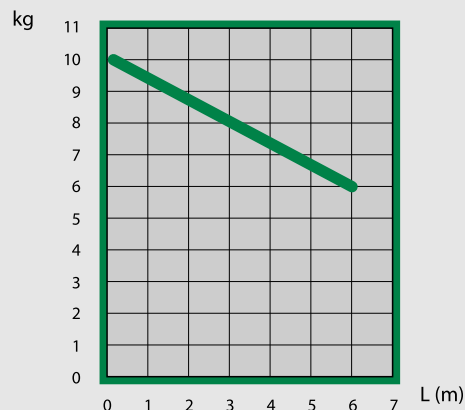

UTILIZZI - USE - USO

SISTEMA PER TENDE ARRICCIATE AD USO DOMESTICO E ALBERGHIERO

- Il sistema è destinato a tende con mantovana applicabile tramite Velcro su un apposito profilo frontale; il sistema permette di installare anche le calate laterali tramite gancio a scatto (art. 4255).
- Azionamento con corde o a strappo
- Indicato per tendaggi L 600 cm max ed H 300 cm di peso fino a 6 kg
- L'apertura può essere centrale, laterale, multipla o asimmetrica
- Il sistema è indicato per installazioni a soffitto o a parete con mensole a sbalzo
- Lo scorrimento delle corde d'azionamento avviene in canali paralleli indipendenti.
- Lo scorrimento è garantito da scioli autolubrificanti in polietilene o da scorrevoli a rullo per i tendaggi ai limiti della portata.

- The system is intended for curtains with a pelmet that can be fitted using Velcro® on a special front section; the system also allows the vertical blinds to be installed using a click hook (art. 4255).
- Cord or hand operated
- For use with curtains 600 cm W max. and 300 cm H weighing up to 6 kg
- The opening can be central, lateral or asymmetric
- The system is suitable for ceiling or wall installation with overhanging brackets
- The operating cords run in independent side-by-side channels.
- Sliding is guaranteed by self-lubricating polyethylene slides or by roller gliders for curtains at the load limit.

SISTEMA PARA CORTINAS ENCRESPADAS DE USO DOMESTICO Y HOTELERO

- El sistema está destinado a cortinas con parte superior aplicable mediante Velcro® en un perfil frontal específico; permite instalar también las piezas laterales de tela mediante gancho de presión (art. 4255)
- Accionamiento mediante cuerdas o de tirón
- Adecuado para cortinas anchura máx. 600 cm y H 300 cm, con peso de hasta 6 kg
- La apertura puede ser central, lateral, múltiple o asimétrica
- El sistema es adecuado para montajes en techo o en pared con ménsulas de salidizo
- El deslizamiento de las cuerdas de accionamiento se verifica en canales paralelos independientes.
- El deslizamiento se efectúa mediante deslizaderas autolubrificantes de polietileno o correderas de rodillo para las cortinas al límite de la capacidad.

CARATTERISTICHE - DESCRIPTION CARACTERÍSTICAS

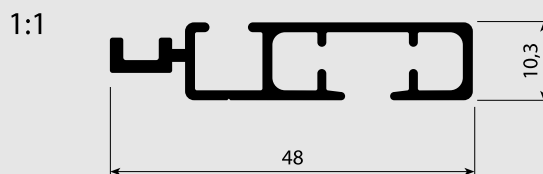

- Profilo in lega d'alluminio estrusa 6060T6 UNI 8278
- Larghezza 48 mm - Altezza 10,3 mm
- Canale di scorrimento: 6 mm
- Finitura superficiale verniciatura poliester bianco RAL 9016
- Carrucole in termoplastico antiurto con ruote su perni in acciaio
- Accessori in acetilica autolubrificante

- 6060T6 UNI 8278 extruded aluminium alloy track
- Width 48 mm - Height 10,3 mm
- Sliding channel: 6 mm
- Surface finish RAL 9016 white polyester paint
- Shockproof thermoplastic pulleys with wheels on steel journals
- Self-lubricating acetylic accessories

- Perfil en aleación de aluminio extruida 6060T6 UNI 8278
- Anchura 48 mm - Altura 10,3 mm
- Canal de deslizamiento: 6 mm
- Acabado de las superficies pintura poliéster blanca RAL 9016
- Garruchas en termoplástico antigolpe con ruedas sobre pernos de acero
- Accesorios de acetálico autolubrificante

APERTURA - OPENING - APERTURA

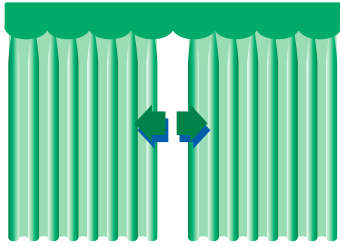

- Centrale
- Central
- Central

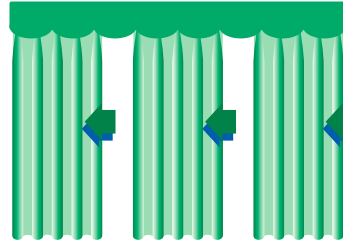

- Multipla
- Multiple
- Multiple

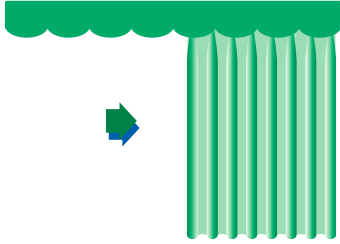

- Laterale
- Lateral
- Lateral

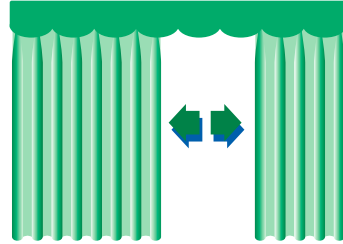

- Asimmetrica
- Asymmetric
- Asimetrica

INSTALLAZIONE - INSTALLATION - INSTALACIÓN

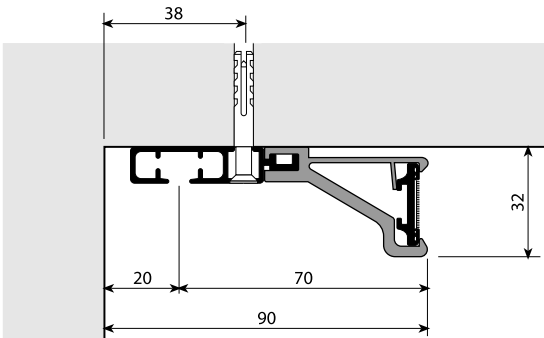
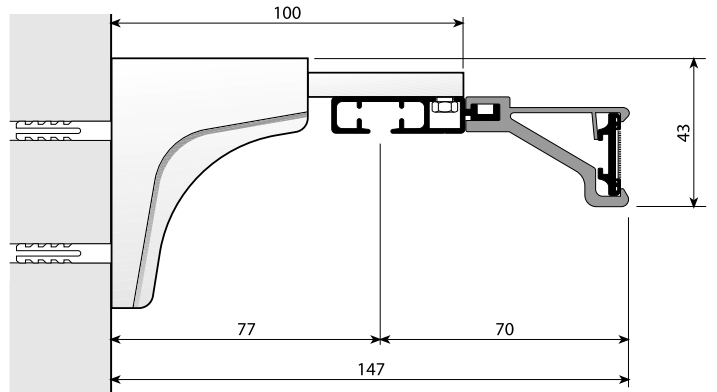
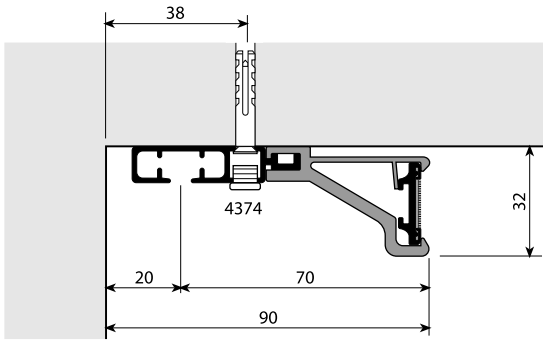

INGOMBRO - OVERALL DIMENSION - ESPESOR

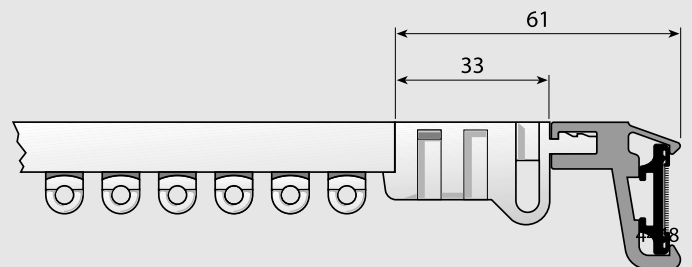

ANGOLI - ANGLES - ÁNGULOS

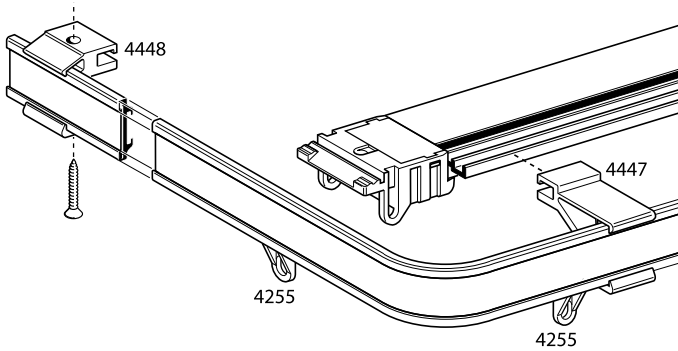

UTILIZZO - USE - USO

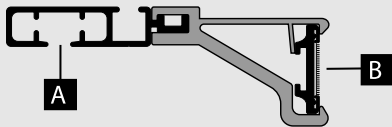

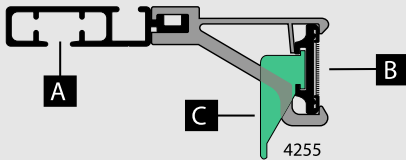
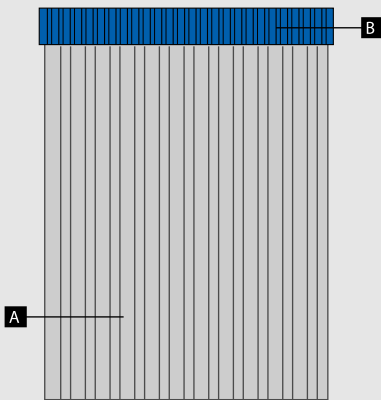

soluz. 1

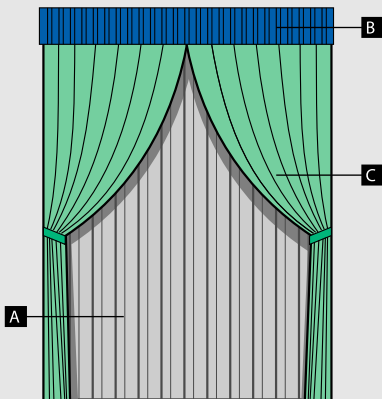

soluz. 2

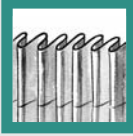

CONFEZIONI CONSIGLIATE - SUGGESTED STYLES OF CURTAINS TIPOS DE CONFECCIÓN

		nastro - tape - cinta
	1:2	art. 768 - h 30 mm
	1:1	art. 768 - h 30 mm

INDICA IL RAPPORTO DI ARRICCIATURA
IT SHOWS THE SPACE BETWEEN THE PLEATS
RAPPORT DE FRUNCIDO

SCIVOLO PER CIALATE LATERALI - GLIDER FOR LATERAL CURTAINS CORREDERA PARA CUIDAS LA TERALES

